

Data Sheet

Customer :

Product : Metal Glazed Leaded Resistor—MGR Series

Size : 0318/0623/0827/0932/0940/1140/1145/1550

Issued Date: 11-Nov-11

Edition : REV.A



VIKING TECH CORPORATION

光頡科技股份有限公司

No.70, Kuanfu N. Rad.,
Hsin Chu Industrial Park,
Hukou Hsiang, Hsin Chu Hsien,
303, Taiwan

TEL:886-3-5972931

FAX:886-3-5972935•886-3-5973494

E-mail:sales@viking.com.tw

VIKING TECH CORPORATION KAOHSIUNG BRANCH

光頡科技股份有限公司高雄分公司

No.248-3, Sin-Sheng Rd., Cian-Jhen Dist., Kaohsiung,
806, Taiwan

TEL:886-7-8217999

FAX:886-7-8228229

E-mail:sales@viking.com.tw

WUXI TMTEC CO., LTD.

無錫泰銘電子有限公司

No.1A,(Xixia Road),Machinery & Industry Park,
National Hi-Tech Industrial Development Zone of
Wuxi, Wuxi, Jiangsu Province, China

Zip Code:214028

TEL:86-510-85203339

FAX:86-510-85203667•86-510-85203977

E-mail:wuxisales@tmtec.com.tw

Produced by (QC)	Checked (QC)	Approved by (QC)	Prepared by (Sales)	Accepted by (Customer)
11-Nov-11	11-Nov-11	11-Nov-11	11-Nov-11	
Kris	Ann	J.C.Liu		

Metal Glazed Leaded Resistor (MGR Series)

Scope

- Coat-Insulated megohm fixed resistors (Metal Glazed)
- High voltage surge resistors

Dimensions

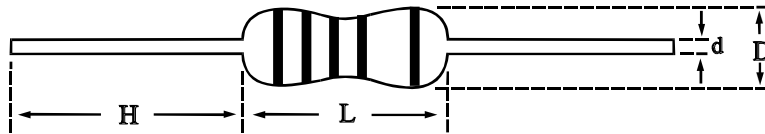

Unit: mm

Type	L	D	H	d
MGR0318	3.3±0.5	1.8±0.3	28±2.0	0.45±0.03
MGR0623	6.3±0.5	2.3±0.3	28±2.0	0.55±0.03
MGR0827	8.5±0.5	2.7±0.5	27±2.0	0.60±0.03
MGR0932	9.0±0.5	3.2±0.5	26±2.0	0.65±0.03
MGR0940	9.0±0.5	4.0±0.5	26±2.0	0.65±0.03
MGR1140	11.5±1.0	4.0±0.5	35±2.0	0.78±0.03
MGR1145	11.5±1.0	4.5±0.5	35±2.0	0.78±0.03
MGR1550	15.5±1.0	5.0±0.5	32±2.0	0.78±0.03

Part Numbering

MGR	0932	F	T	F	U	1004	S
Product Type	Dimensions (LxD)	Resistance Tolerance	Packaging Code	TCR (PPM/°C)	Power Rating	Resistance	Special
	0318: 3.3x1.8 0623: 6.3x2.3 0827: 8.5x2.7 0932: 9.0x3.2 0940: 9.0x4.0 1140: 11.5x4.0 1145: 11.5x4.5 1150: 15.5x5.0	F: ±1% J: ±5% K: ±10%	A: Ammo T: Taping Reel	E: ±100 F: ±200	: Standard W: 1/8W V: 1/4W U: 1/2W T: 1W S: 2W R: 3W	1003: 100KΩ 1004: 1MΩ 1007: 1GΩ	S: Silicone Resin E: Epoxy Resin

Derating Curve

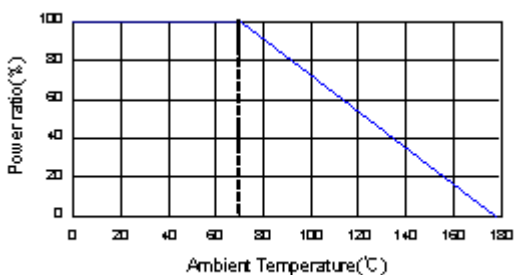

Surface Temp Rise

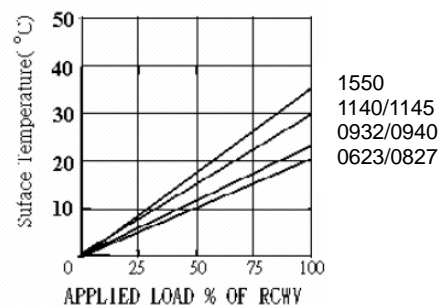

Standard Electrical Specifications

Item Type	Power Rating at 70°C	Operating Temp. Range	Max. Working Voltage	Max. Overload Voltage	Dielectric Withstanding Voltage		Resistance Range			TCR (PPM/°C)
					Silicone Resin	Epoxy Resin	±1%	±5%	±10%	
0318	1/8W	-55 ~ +175°C	DC500V	1000V	300V	400V	100KΩ ~ 100MΩ			±100
0623	1/4W		DC1600V	DC2000V	400V	500V	100KΩ~100MΩ			±100
			AC1150V	AC1500V			101MΩ~500MΩ	501MΩ~1GΩ	±200	
0932	1/2W		DC2000V	2500V	500V	700V	100KΩ~100MΩ			±100
							101MΩ~500MΩ	501MΩ~1GΩ	±200	
1140	1W		DC3000V	4000V	500V	1000V	100KΩ~100MΩ			±100
				101MΩ~500MΩ			501MΩ~1GΩ	±200		
1550	2W	DC3500V	4000V	700V	1200V	100KΩ~100MΩ			±100	
						101MΩ~500MΩ	501MΩ~1GΩ	±200		

Power Rating Electrical Specifications

Item Type	Power Rating at 70°C	Operating Temp. Range	Max. Working Voltage	Max. Overload Voltage	Dielectric Withstanding Voltage		Resistance Range			TCR (PPM/°C)
					Silicone Resin	Epoxy Resin	±1%	±5%	±10%	
0623	1/2W	-55 ~ +175°C	DC1700V	2500V	400V	500V	100KΩ~100MΩ			±100
							101MΩ~500MΩ	501MΩ~1GΩ	±200	
0827	1/2W		DC1800V	2500V	400V	500V	100KΩ~100MΩ			±100
							101MΩ~500MΩ	501MΩ~1GΩ	±200	
0940	1W		DC2500V	3500V	500V	700V	100KΩ~100MΩ			±100
							101MΩ~500MΩ	501MΩ~1GΩ	±200	
1145	2W	DC3500V	4000V	500V	1000V	100KΩ~100MΩ			±100	
						101MΩ~500MΩ	501MΩ~1GΩ	±200		
1550	3W	DC3500V	4000V	700V	1200V	100KΩ~100MΩ			±100	
						101MΩ~500MΩ	501MΩ~1GΩ	±200		

■Silicone Resin coating color : Brown (Flame-Proof)

Epoxy Resin coating color : Light Blue

Environmental Characteristics

Item	Requirement	Test Method
Short Time Overload	±(1.0%+0.05Ω)	JIS-C-5201-1 5.5 RCWV*2.5 or Max. overload voltage for 5 seconds
Insulation Resistance	±10,000MΩ Over	MIL-STD-202F Method 302 500±50V DC During 1 min V-Block method
Endurance	±(3.0%+0.05Ω)	MIL-STD-202F Method 108A 70±2°C, Max. working voltage for 1000 hrs with 1.5 hrs "ON" and 0.5 hrs "OFF"
Damp Heat with Load	±(5.0%+0.05Ω)	MIL-STD-202F Method 103B 40±2°C, 90~95% R.H. Max. working voltage for 1000 hrs with 1.5 hrs "ON" and 0.5 hrs "OFF"
Dielectric Withstanding Voltage	By Type	MIL-STD-202F Method 301 In V-Block for 1 minute
Pulse Overload	±(1.0%+0.05Ω)	JIS-C-5201-1 5.8 4 times RCWV for 10000 cycles with 1sec "ON" and 25 sec "OFF"
Resistance To Soldering Heat	±(1.0%+0.05Ω)	260°C±5°C for 10±1 seconds or 350°C±10°C for 3.5±0.5 seconds
Terminal Strength	Tensile: ≥ 2.5kg	Direct Load for 10 sec. In the direction off the terminal leads

■ Storage Temperature: 25±3°C; Humidity < 80%RH

■ Taping/Packing Specifications

1. Standard Type (Reel & Ammo)

Packing Methods

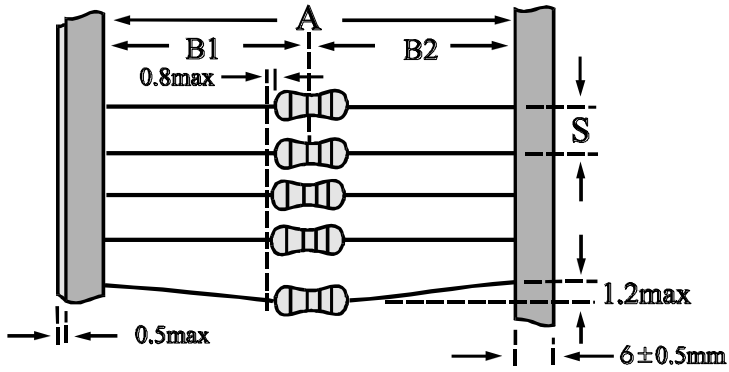

Reel Packing

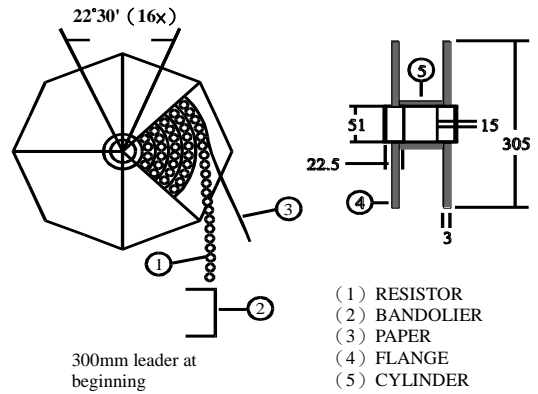

Ammo Packing

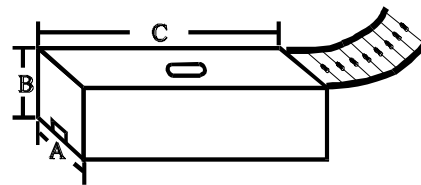

Unit: mm

Packaging Type	Packing Methods			Reel Packing		Ammo Packing			
	A	B1-B2 Max	S	Across Flange (A)	Qty	A	B	C	Qty
0318	52+1/-0	1.2	5	72	5,000	80	75	264	5,000
0623	52+1/-0	1.2	5	72	5,000	80	105	264	5,000
0827	52+1/-0	1.2	5	72	2,500	80	46	264	1,000
0932	52+1/-0	1.2	5	72	2,500	80	46	264	1,000
0940	52+1/-0	1.2	5	72	2,500	80	46	264	1,000
1140	52+1/-0	1.5	5	95	2,000	103	82	265	1,000
1145	52+1/-0	1.5	5	95	2,000	103	82	265	1,000
1550	52+1/-0	1.5	10	95	1,000	103	96	265	1,000

■ Marking & Resistance Tolerance

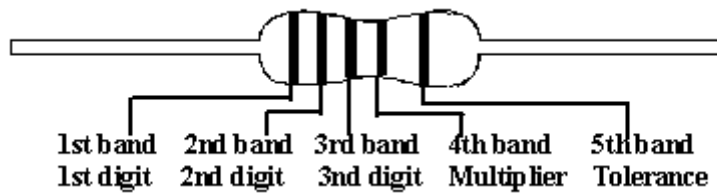
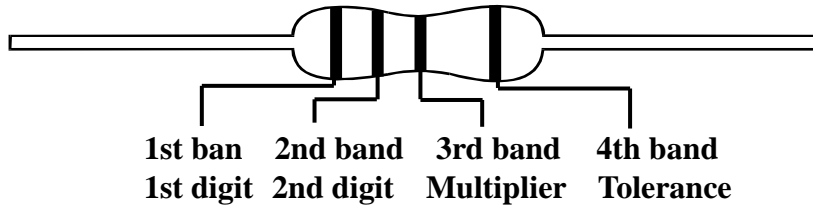

Color	Digit	Multiplier	Tolerance	
Without	-	-	-	-
Silver	-	10^{-2}	$\pm 10\%$	K
Gold	-	10^{-1}	$\pm 5.0\%$	J
Black	0	10^0	-	-
Brown	1	10^1	$\pm 1.0\%$	F
Red	2	10^2	-	-
Orange	3	10^3	-	-
Yellow	4	10^4	-	-
Green	5	10^5	-	-
Blue	6	10^6	-	-
Violet	7	10^7	-	-
Grey	8	10^8	-	-
White	9	10^9	-	-

$\pm 10\%$	E-12	1.0	-	1.2	-	1.5	-	1.8	-	2.2	-	2.7	-	3.3	-	3.9	-	4.7	-	5.6	-	6.8	-	8.2	-
$\pm 5.0\%$	E-24	1.0	1.1	1.2	1.3	1.5	1.6	1.8	2.0	2.2	2.4	2.7	3.0	3.3	3.6	3.9	4.3	4.7	5.1	5.6	6.2	6.8	7.5	8.2	9.1
$\pm 1.0\%$																									